



# Test Certificate

Part Automated Disintegration Basket  
(for 6 Tubes, 10 mesh)

Part Number 14678-01

Serial Number 6302 - 6356

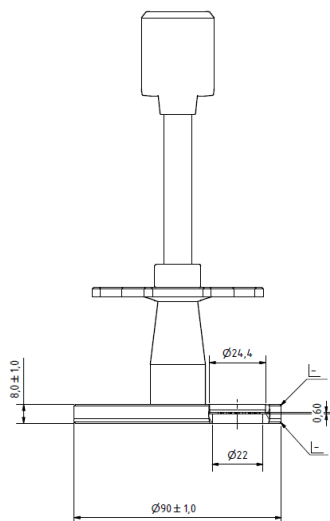

Effective dimension

	USP / Ph.Eur	Tolerances
<b>Dimensions</b>	Bottom plate Ø	90.0 mm ± 2.0 mm
	Bottom thickness	6.75 mm ± 1.75 mm
	6 Holes Ø	24 mm ± 2.00 mm
	Mesh apertures	1.8 to 2.2 mm --
	Mesh wire	0.57 to 0.66 mm --
<b>Material</b>	PMMA, POM, PVC, PA, Stainless Steel	

USP / Ph.Eur conformity (acc. USP701 / Ph Eur 2.9.1) :

The design of the basket-rack assembly may be varied somewhat, provided the specifications for the glass tubes and the screen mesh size are maintained.

(separate Certificates for Glass tube #12514)

The accuracy of the above mentioned part dimensions have been examined. All relevant measurements are within tolerance and the factory acceptance test has passed.

Aesch, 2021-11-11

Bruno Balli  
SOTAX Quality Management  
SOTAX AG | Nordring 1 | 4147 Aesch | Switzerland